

Controller Kit Installation Manual MIFH1, MRCH1, MCCH1, MOS1

Installation guide for:

- Wireless Receiver and Cable (MIFH1)
- Remote Controller (MRCH1)
- Portable Central Controller (MCCH1)
- Outdoor Air Sensor (MOS1)



DISCONNECT POWER BEFORE BEGINNING INSTALLATION. Can cause electrical shock or equipment damage.



Must be installed by a trained, experienced technician. Read these instructions carefully. Failure to follow these instructions can damage the product or cause a hazardous condition.

Installation at a glance

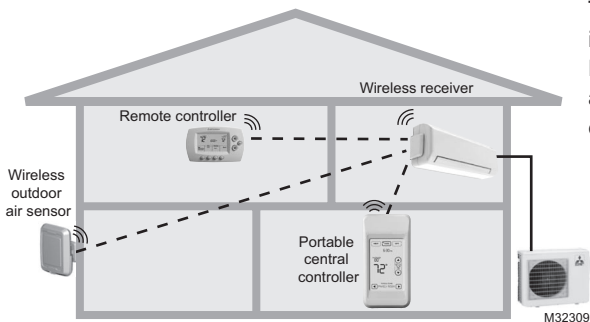

This document covers linking and installation procedures for the Mitsubishi Split-Zoning Ductless and Ducted Systems' RedLINK™ control devices and accessories.

Before you begin, you must attach the cable to the CN105 connector on the indoor unit control board, then follow the steps in this document.



Remote controllers are linked to specific indoor units. Each indoor unit must have a dedicated remote controller and wireless receiver.



1 Install batteries in wireless devices

Install batteries in all devices. Make sure batteries are inserted properly (see polarity marks on the devices).

Remote Controller

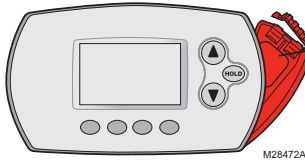

Install 2 fresh AA batteries

Install quick reference card

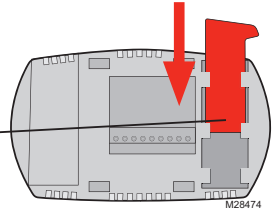

Portable Central Controller (optional): Install 3 fresh AA batteries

Outdoor air sensor (optional): Install 2 fresh AA **lithium** batteries

2 Install cable and receiver

- 1 Before mounting indoor unit, connect cable to the 5-pin CN105 connector on the control board in the indoor unit.
- 2 Mount indoor unit. Route cable to preferred location of the wireless receiver.
- 3 Route cable through hole in base of wireless receiver and attach to 5 pin connector on receiver board.
- 4 Push the excess cable back through the indoor unit or behind the wireless receiver. Do not cut or modify the cable. Use zip tie connections on back of receiver if needed.
- 5 Mount wireless receiver next to the indoor unit (see below) or in a remote location.
Mount in the orientations shown. Do not block vents.

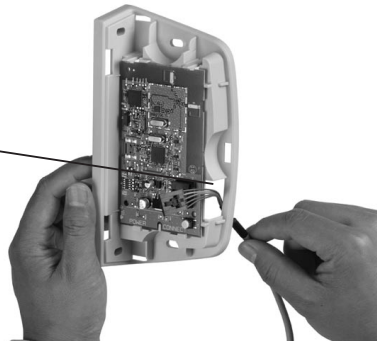

MCR31400

③ Link all devices to wireless network

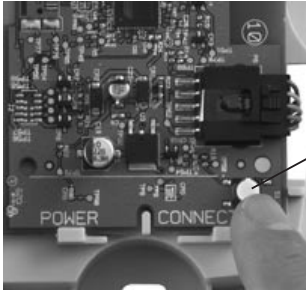

- 1 Remove cover from wireless receiver.
- 2 Verify POWER light is solid green.
- 3 Press and release the **CONNECT** button.
- 4 If CONNECT light does not flash, another receiver or RedLINK wireless adapter may be in wireless setup mode. Exit wireless setup at the other device.

POWER LED

Solid Green: Powered and communication is established.

Slow Flashing Green (1 flash/second): Receiver is powered. Wait approximately 30 seconds for communication to be established between the wireless receiver and the indoor unit. Check cable connection if flashing does not stop after 30 seconds.

Fast Flashing Green (5 flashes/second): Error in communication between wireless receiver and the indoor unit. Check cable connection.

CONNECT LED

Flashing Green: In wireless setup mode.

Solid Green: RedLINK communication is established.

Yellow: Please wait.

Red: RedLINK device is not communicating.



Flashing status light times out after 15 minutes of inactivity. Press **CONNECT** again if necessary.

Link remote controller to wireless network

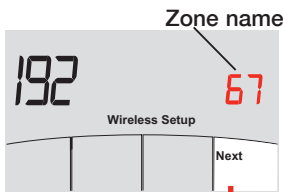

Press **▲** or **▼** to change the name or location of this zone, then press **NEXT**.

Example: 67 = Meeting Room



See complete zone list on page 8.

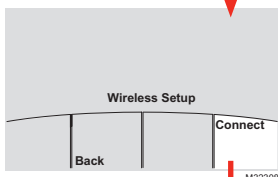

Press **CONNECT** to establish a link to the wireless network.



If E0 or E1 appears, see error codes on page 10.

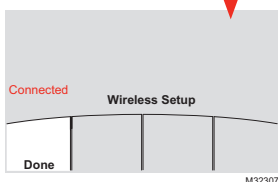

After a brief pause, the confirmation screen at left should be displayed to verify that the wireless connection has been established.

Press **DONE** to display the home screen.

Link Portable Central Controller to RedLINK™ network (optional)

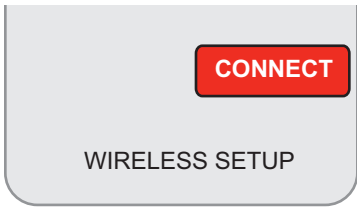

M28481

Press to link another receiver

Press to save and exit

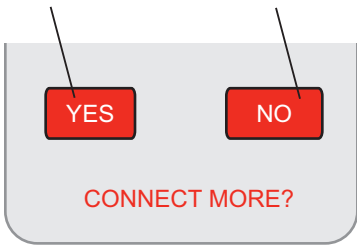

M28482

- 1 Make sure the **CONNECT** light on the wireless receiver is flashing.
- 2 Press **CONNECT** at the Portable Central Controller. There will be a short delay as the Portable Central Controller seeks a signal from the wireless network.
- 3 When the screen displays "Connected," press **DONE**.
- 4 Press **NO** at the next screen to save and exit. (Or press **YES** and repeat steps 1-4 to link another receiver.)



If E1 appears, see error codes on page 10.



The linking procedure may time out if there is no keypress within 15 minutes. To begin again, press and hold the blank space (or arrow, if present) in the lower right corner of the screen until the display changes (about 3 seconds).



Link outdoor sensor to RedLINK™ network (optional)

Press and release

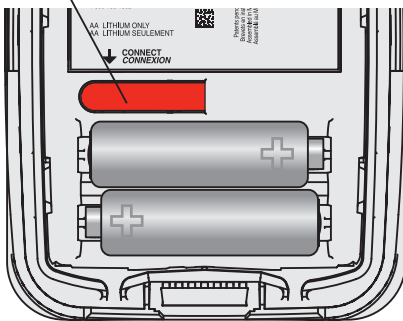



M28483

- 1 Make sure the **CONNECT** light on the wireless receiver is flashing.
- 2 Press and release the **CONNECT** button on the back of the sensor.
- 3 Check remote controller to verify that the outdoor sensor is working. After about 15 seconds, the remote controller should display outdoor temperature and humidity.

Exit wireless setup

Press and release the **CONNECT** button at the wireless receiver to exit wireless setup (light should stop flashing and remain solid). Replace cover on wireless receiver.

 **Note:** The wireless receiver will automatically exit wireless setup after 15 minutes of inactivity.

 **Note:** If installing more than one receiver, you must exit wireless setup before installing remote controller and additional receiver.

4 Customize remote controller (installer setup)

Follow the steps below to begin installer setup. At each function screen, press **▲** or **▼** to change the setting as desired, then press **NEXT** to advance to the next function screen.

See tables on pages 6-8 for a description of options for each function.

To begin, **press and hold** the **FAN** and **▲** buttons until the display changes. "WAIT" will be displayed for up to 40 seconds.

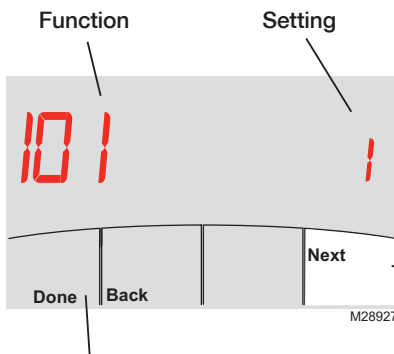
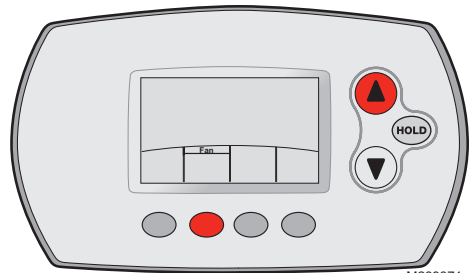

Press **▲** or **▼** to change setting (see tables on pages 6-8).

Press **NEXT** to display next function screen.

Press **DONE** to save & exit.

Installer setup tables

 Default settings for Setup functions 101-128 are automatically determined by the HVAC equipment. It may take up to 40 seconds to enter setup, and 30 seconds to exit setup.

Setup function	Settings & options (factory default in bold)
101 Unit automatically restarts after power outage	1 OFF
	2 ON
	3 Not Supported
103 Ventilation Air	1 Not Supported
	2 IDU does not intake outdoor air through LOSSNAY
	3 IDU does intake outdoor air through LOSSNAY
104 Power Voltage	1 230V
	2 208V
	3 Not Supported
105 Auto energy-savings operation	1 ON
	2 OFF
	3 Not Supported
107 Change Filter Duration	1 100 Hours
	2 2500 Hours
	3 OFF
108 Auto Fan (speed setting)	1 Quiet
	2 Standard
	3 High Ceiling
109 No. of Air Outlets (PLA only)	1 4 directions
	2 3 directions
	3 2 directions
110 High Performance Filter Installed	1 NO
	2 YES
	3 Not Supported
111 Airflow Direction Settings	1 No Vanes (or Vane #3 for PLA)
	2 Vane #1 Setting (typically kept at the default setting)
	3 Vane #2 Setting (typically kept at the default setting)
115 Indoor Unit Coil Frost Prevention Temperature	1 36 °F (2 °C)
	2 37 °F (3 °C)
	3 Not Supported
117 Defrost Control	1 Standard
	2 High Humidity
	3 Not Supported
123 Airflow Oscillate Mode	1 Not Available
	2 Available
	3 Not Supported
124 Heating Mode Temperature Offset	1 ON
	2 OFF
	3 Not Supported
125 Thermal Off Fan Operation (Heat Mode)	1 Extra Low
	2 Stop
	3 Selectable Fan Speed
127 Thermal Off Fan Operation (Cool Mode)	1 Selectable Fan Speed
	2 Stop
	3 Not Supported
128 Display System Error	1 ON
	2 OFF
	3 Not Supported

Installer setup tables

Setup function		Settings & options (factory default in bold)	
134	Central Controller (AG-150 or similar) Present	0	Not Installed
		1	Installed
136	Residential/Commercial	1	Commercial
		0	Residential
138	Permanent Hold Lock (Non-programmable)	0	OFF (Programmable)
		1	ON (Non-programmable)
139	Fahrenheit/Celsius Display	0	Fahrenheit
		1	Celsius
140	Commercial Override Duration	3	3 Hours
		0	OFF
		1-12	1-12 Hours
142	System Type	0	Heat & Cool (Heat Pump)
		1	Cool Only
144	System Changeover	1	System Changeover (Auto, Heat, Off, Cool)
		0	Manual Changeover (Heat, Off, Cool)
		2	System Changeover Only (Auto Only)
		3	System Changeover Single Setpoint - only with AG-150 or similar (Auto, Heat, Off, Cool)
145	System Changeover Deadband Value	3	3 °F (2 °C)
		2-8	2-8 °F (1.5-4.5 °C)
146	Drying Mode	0	OFF
		1	ON
148	Schedule Format	0	5-2
		1	5-1-1
150	Optimal Start	1	ON
		0	OFF
152	Scheduled Off	0	Not Shown *See page 9 for feature information
		1	Shown
154	Power Off Timer ("Sleep Timer")	0	Not Shown
		1	Resume operation at next scheduled period
		2	Permanently Off until user changes System mode
160	Full Lockout	0	No
		1	Yes
162	Lockout On/Off	0	No
		1	Yes
164	Lockout System Mode (Heat, Cool, Auto, Drying)	0	No
		1	Yes
165	Lockout Fan Mode	0	No
		1	Yes
166	Lockout Setpoint	0	No
		1	Yes
168	Lockout Set Clock/Day/Schedule	0	No
		1	Yes
170	Max Heat Setpoint	90	90 °F (32 °C) * Subject to
		40-89	40 to 89 °F (4.5 to 31.5 °C) HVAC Equipment
172	Min Cool Setpoint	50	50 °F (10 °C) * Subject to
		51-99	51 to 99 °F (10.5 to 37 °C) HVAC Equipment
173	Sensing Location	1	Sense at Remote Controller
		0	Sense at Indoor Unit
174	Indoor Temperature Display Offset	0	0 °F (0 °C)
			-3 to 3 °F (-1.5 to 1.5 °C)

Installer setup tables

Setup function		Settings & options (factory default in bold)	
176	Outdoor Temperature	0	0 °F (0 °C)
	Display Offset		-5 to 5 °F (-2.5 to 2.5 °C)
178	Outdoor Humidity	3	0%
	Display Offset	0	-15%
		1	-10%
		2	-5%
		4	5%
		5	10%
		6	15%
192	Zone Name	52	THERMOSTAT
		1	BASEMENT
		2	BATHROOM
		3	BATHROOM 1
		4	BATHROOM 2
		5	BATHROOM 3
		6	BEDROOM
		7	BEDROOM 1
		8	BEDROOM 2
		9	BEDROOM 3
		10	BEDROOM 4
		11	BOAT HOUSE
		12	BONUS ROOM
		13	COMPUTER ROOM
		14	DEN
		15	DINING ROOM
		16	EXERCISE ROOM
		17	FAMILY ROOM
		18	FIREPLACE
		19	FOYER
		20	GAME ROOM
		21	GARAGE
		22	GREAT ROOM
		23	GUEST ROOM
		24	GYM
		25	KID'S ROOM
		26	KITCHEN
		27	KITCHEN 1
		28	KITCHEN 2
		29	LAUNDRY ROOM
		30	LIBRARY
		31	LIVING ROOM
		32	LOWER LEVEL
	33	MASTER BATH	
		34	MASTER BED
		35	MEDIA ROOM
		36	MUSIC ROOM
		37	NURSERY
		38	OFFICE
		39	OFFICE 1
		40	OFFICE 2
		41	PANTRY
		42	PLAYROOM
		43	POOL ROOM
		44	PORCH
		45	REC ROOM
		46	SEWING ROOM
		47	SPA
		48	STORAGE ROOM
		49	STUDIO
		50	SUN ROOM
		51	THEATER
		52	THERMOSTAT
		53	UPPER LEVEL
		54	UTILITY ROOM
		55	WALK IN CLOSET
		56	WINE CELLAR
		57	WORKSHOP
			Commercial Names
		64	CONFERENCE RM
		65	DRESSING ROOM
		66	MACHINE ROOM
		67	MEETING ROOM
		68	OPEN AREA 1
		69	OPEN AREA 2
		70	SERVER 1
		71	SERVER 2
		72	STOCK ROOM
194	Wireless Setup	1	Remote controller is connected to wireless system
		0	Disconnect Remote controller from wireless system
198	Reset Schedule to Factory Defaults	0	No
		1	Yes
199	Reset Installer Setup to Factory Defaults	0	No
		1	Yes

Special functions

Commercial Override (Setup Function 140): Allows an employee during an unoccupied period to temporarily activate an occupied temperature. Each press of **HOLD** extends the occupied temperature out 1 hour (or as installed).

Optimal Start (Setup Function 150): Allows the remote controller to “learn” how long the equipment will take to reach programmed temperature settings, so the temperature is reached at the scheduled time.

Scheduled Off (Setup Function 152): Allows the user to schedule a period where the split-zoning system is completely off and resumes operation at the next scheduled period.

Power Off Timer (Setup Function 154): Allows user to schedule indoor unit completely off for one instance:

Follow Schedule Option: indoor unit will resume operation at the next scheduled period.

Permanently Off Option: indoor unit will remain off indefinitely until the user changes the system mode.

Installer test

Follow the procedure below to test for proper operation.

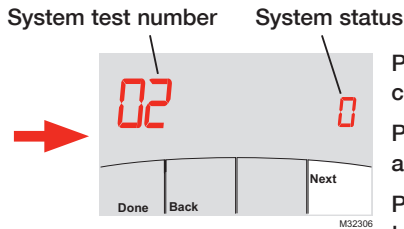
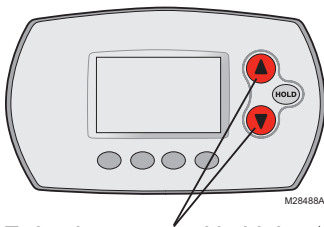

Press ▲ or ▼ to check system status

Press **NEXT** to advance to next test

Press **DONE** to terminate system test

To begin, press and hold the ▲ and ▼ buttons until the display changes (about 3 seconds).

System test	System status
02 Wireless test	0 Off 1 Test radio signal (after a brief pause, screen displays 5-10 to show signal strength; 5 or higher recommended)
50 Cool/Heat test	0 Off 1 Cool 2 Heat
70 Configuration Data 1 (remote controller)	71 Software revision number (major revisions) 72 Software revision number (minor revisions) 73 Configuration identification code (major) 74 Configuration identification code (minor) 75 Production configuration date code (week) 76 Production configuration date code (year)
80 Configuration Data 2 (remote controller)	81 Software revision number (major revisions) 82 Software revision number (minor revisions) 83 Software revision number (build revisions)
90 Configuration Data 1 (wireless receiver)	91 Software revision number (major revisions) 92 Software revision number (minor revisions) 93 Software revision number (build revisions)
95 Configuration Data 2 (wireless receiver)	95 Software revision number (major revisions) 96 Software revision number (minor revisions) 97 Software revision number (build revisions)

5 Mount remote controller & outdoor sensor

- 1 Separate the wallplate from the remote controller.
- 2 Mount the wallplate using the included screws and anchors 5 feet from the floor on an interior wall. If the remote controller is configured to sense indoor temperature, mount in the same room as the indoor unit.
Drill 3/16" holes for drywall.
Drill 7/32" holes for plaster.
- 3 Snap the remote controller to the wallplate on the wall.

Outdoor sensor (optional)

Mount the sensor on a vertical exterior wall, at least 6 inches below any overhang. Choose a location protected from direct sunlight.

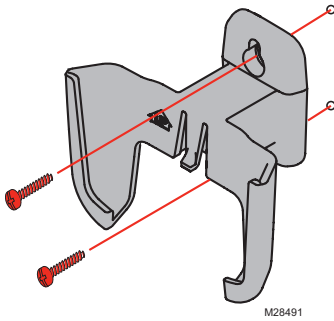

Place sensor securely
in bracket, facing
away from wall.

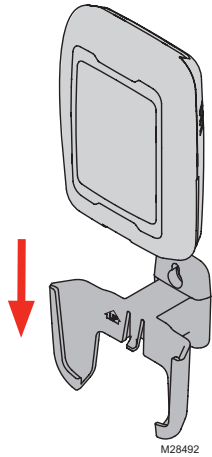

RedLINK™ error codes

- E0 27** Verify device temperature is within operating range. If within range for at least 30 minutes and problem persists, replace Remote Controller.
- E0 91** Communication was established between wireless receiver and the indoor unit, but communication has been lost for 10 minutes. Check cable connection. Try replacing the cable.
- E1 29** Attempting to connect incompatible wireless devices.
- E1 34** Low signal strength. Move wireless device to a different location and try again.
- E1 38** Make sure Connect light on wireless receiver is flashing and you are 2+ feet away from wireless receiver.
- E1 54** Indoor unit does not support wireless receiver.

For full list of error codes, please refer to your equipment's technical service manual.

Replacing system components

Note: Only use Mitsubishi Electric components or other designated components for installation. Failure to comply may damage the product or cause a hazardous condition.

Remote Controller

To replace a remote controller, install batteries and follow the procedures on page 3 to link it to the wireless network. If necessary, modify settings as needed (see tables on pages 6–8).

Portable Central Controller & outdoor sensor

To replace a Portable Central Controller or outdoor air sensor, install batteries and follow the procedures on page 4 to link it to the wireless network.

Wireless receiver

After installing a new wireless receiver, you must re-set the remote controller and Portable Central Controller to communicate with the new equipment, as described below.

At the remote controller:

- 1 Press and hold the **FAN** and **▲** buttons for 3 seconds until display changes. "WAIT" will be displayed for up to 17 seconds.
- 2 Press **NEXT** until Function 194 is displayed (wireless setup).
- 3 Press **▼** to change Function 194 setting to 0 (disconnect from old wireless receiver).
- 4 Follow the procedures on page 3 to link to new wireless receiver.

At the Portable Central Controller:

- 1 Press and hold the blank space (or arrow if present) in the lower right corner of the screen until the display changes (about 3 seconds).
- 2 Press **REMOVE**, then **YES** to disconnect from old wireless receiver.
- 3 Follow the procedure on page 4 to link to new wireless receiver.



Removing all wireless devices:

- 1 Press and hold the **CONNECT** button on the wireless receiver for 10 seconds.
- 2 To reconnect, see procedure on page 3.

Regulatory information

FCC Compliance Statement (Part 15.19) (USA only)

This device complies with Part 15 of the FCC Rules. Operation is subject to the following two conditions:

- 1 This device may not cause harmful interference, and
- 2 This device must accept any interference received, including interference that may cause undesired operation.

FCC Warning (Part 15.21) (USA only)

Changes or modifications not expressly approved by the party responsible for compliance could void the user's authority to operate the equipment.

FCC Interference Statement (Part 15.105 (b)) (USA only)

This equipment has been tested and found to comply with the limits for a Class B digital device, pursuant to Part 15 of the FCC Rules. These limits are designed to provide reasonable protection against harmful interference in a residential installation. This equipment generates uses and can radiate radio frequency energy and, if not installed and used in accordance with the instructions, may cause harmful interference to radio communications. However, there is no guarantee that interference will not occur in a particular installation. If this equipment does cause harmful interference to radio or television reception, which can be determined by turning the equipment off and on, the user is encouraged to try to correct the interference by one of the following measures:

- Reorient or relocate the receiving antenna.
- Increase the separation between the equipment and receiver.
- Connect the equipment into an outlet on a circuit different from that to which the receiver is connected.
- Consult the dealer or an experienced radio/TV technician for help.

Wireless receiver, remote controller and outdoor sensor

To comply with FCC and Industry Canada RF exposure limits for general population/ uncontrolled exposure, the antenna(s) used for these transmitters must be installed to provide a separation distance of at least 20 cm from all persons and must not be co-located or operating in conjunction with any other antenna or transmitter.

Portable Central Controller

This portable transmitter with its antenna complies with FCC and Industry Canada RF exposure limits for general population/ uncontrolled exposure. This device must not be co-located or operating in conjunction with any other antenna or transmitter.

Section 7.1.5 of RSS-GEN

Operation is subject to the following two conditions:

- 1 this device may not cause interference, and
- 2 this device must accept any interference, including interference that may cause undesired operation of the device.

Specifications & replacement parts

Operating Ambient Temperature

Remote Controller: 32 to 120° F (0 to 48.9° C)

Portable Central Controller: 32 to 120° F (0 to 48.9° C)

Wireless receiver: -40 to 165° F (-40 to 73.9° C)

Outdoor air sensor: -40 to 140° F (-40 to 60° C)

Operating Relative Humidity

Remote Controller: 5% to 90% (non-condensing)

Portable Central Controller: 5% to 90% (non-condensing)

Wireless receiver: 5% to 95% (non-condensing)

Outdoor air sensor: 0% to 100% (condensing)

Physical Dimensions (height, width, depth)

Remote Controller: 3-9/16 x 5-13/16 x 1-1/2 inches (91 x 147 x 38 mm)

Wireless receiver: 6-7/16 x 3-1/4 x 1-5/16 inches (164 x 82.5 x 34 mm)

Outdoor air sensor: 5 x 3-1/2 x 1-11/16 inches (127 x 89 x 43 mm)

Portable Central Controller: 6-1/4 x 3-1/8 x 1-5/8 inches (158.2 x 79.9 x 42 mm)

Accessories & Replacement Parts

Item	Part Number
Portable Central Controller	MCCH1
Outdoor air sensor	MOS1
Remote Controller	MRCH1
Receiver and Cable	MIFH1
Cable	MRC1

